

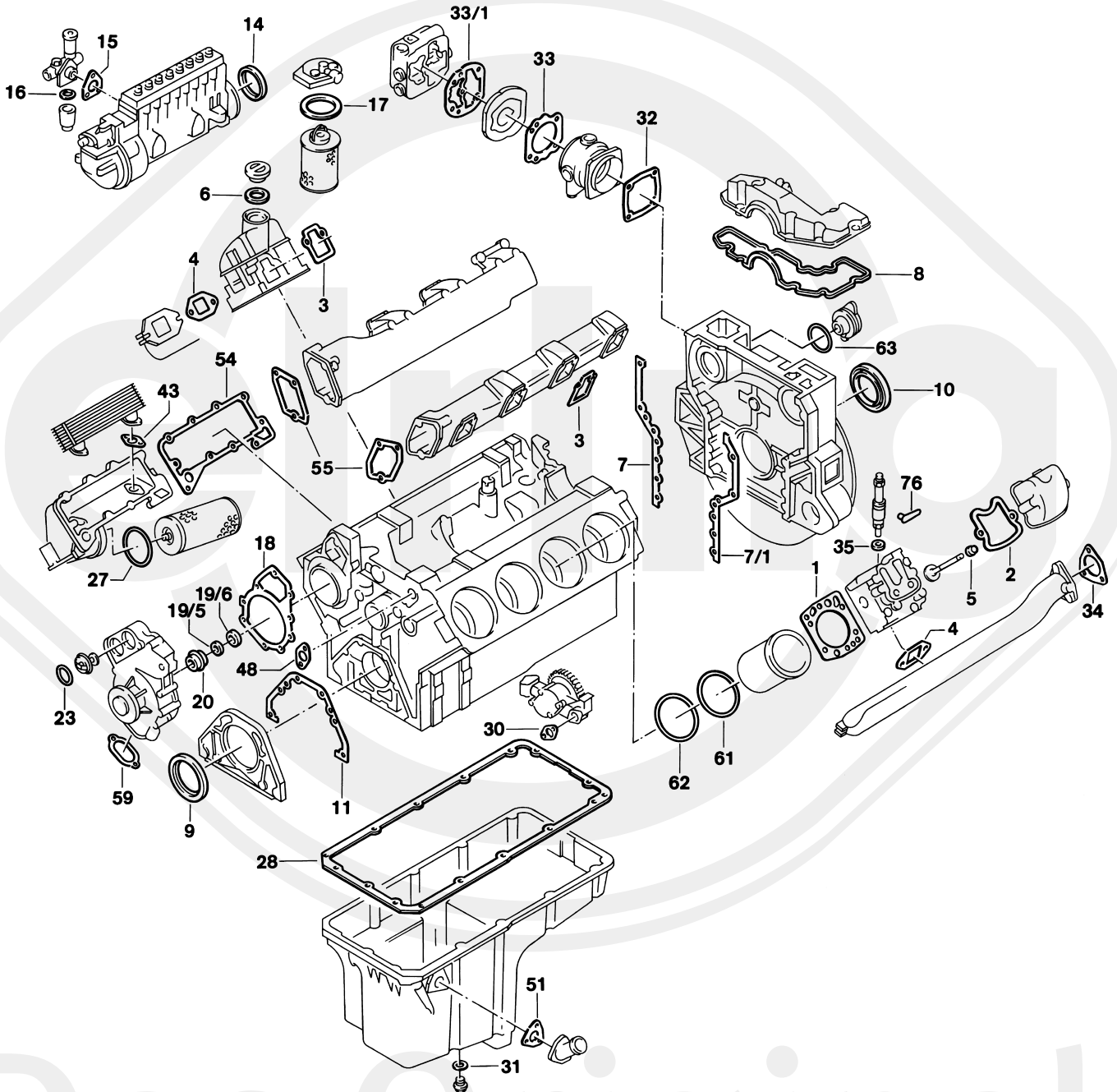

Das Original

Mercedes-Benz

OM 442



Das Original



440.907 | 909

442.900 | 905-911 | 914-935 | 939

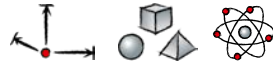









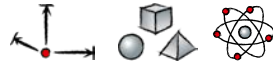













S ⊕*	914.967	1x	-	-	896.510
ES	812.544	8x	444 010 01 20	-	896.510
ES	812.545	8x	444 010 01 20	-	412.180
ES ⊕	812.529	8x	-	-	748.080
ES ⊕	413.810	8x	-	-	896.510 562.298
ES ⊕	570.282	8x	-	-	896.510 391.190
CS *	812.579	1x	422 010 06 08	-	
ZLBS	542.370	8x	-	-	Ø 145,8 mm → 535118
ZLBS	542.380	8x	-	-	Ø 145,8 mm incl. 703.214 535119 →
ZLBS	827.541	8x	-	-	→ 535118
ZLBS	827.568	8x	-	-	535119 → incl. 703.214
WPS	812.617	1x	422 200 09 01	-	Ø 15 mm
SZ	812.552	1x	423 010 48 33	-	-
ZKS	820.091	8x	-	M15x2x109 M15x2x144 M15x2x168	-
1	748.080	8x	422 016 06 20	Ø 143,5 mm $\frac{\text{H}}{\text{h}}$ 1,23 mm	-
1	748.110	8x	422 016 07 20	Ø 143,5 mm $\frac{\text{H}}{\text{h}}$ 1,33 mm 2 ▽	-
1	896.510	8x	442 016 03 20	Ø 143,5 mm $\frac{\text{H}}{\text{h}}$ 1,25 mm	galvanized/verzinkt
1	412.180	8x	442 016 04 20	Ø 143,5 mm $\frac{\text{H}}{\text{h}}$ 1,25 mm	stainless steel/Edelstahl
2	977.438	8x	442 016 06 21	-	-
3	896.365	8x	442 141 17 80	-	-
4	225.126	8x	403 142 03 80	-	-
5	562.298	16x	422 053 01 96	12x15,7/20x15 FPM	-
	391.190	16x	403 053 01 96	12x15,7/20x15 AEM	-
7	819.191	1x	442 015 01 80	-	-
7/1	819.205	1x	442 015 00 80	-	-
8	759.139	1x	442 015 00 60	-	-
9	524.973	1x	014 997 46 47	105x130x12 AW/BS RD FPM	476.070



440.907 | 909

442.900 | 905-911 | 914-935 | 939













9	766.853	1x	-	105x130x12 AW/BS RD PTFE/ACM	 476.070
9	369.901	1x	025 997 39 47	100x130x11 ASW RD PTFE/ACM	-
10	562.920	1x	013 997 14 47	120x140x13 AW/BS LD FPM	 834.289
10	766.829	1x	-	120x140x13 AW/BS LD PTFE/ACM	 834.289
10	354.090	1x	025 997 50 47	115x140x12 ASW LD PTFE/ACM	-
11	756.769	1x	442 011 00 80	-	-
14	759.147	1x	442 074 00 59	94,5x105,3x9 ACM PR	-
15		1x	001 074 22 80	-	-
16	716.200	1x	000 997 00 40	28x36x2 NBR A	-
17	733.431	1x	000 477 31 80	95x103x3 NBR A	-
18	756.882	1x	442 201 00 80	-	-
20	577.804	1x	001 201 19 19	-	-
23	495.980	2x	024 997 28 48	58,5x67,5x4,3 EPDM PR	-
27	780.103	1x	008 997 70 45	134x4 NBR RD	-
28	765.718	1x	442 014 02 22	-	
30	759.300	1x	917003 036003	-	-
31	031.046	1x	007603 026109	26x34x2 CU A	-
32	374.690	1x	442 131 27 80	-	-
33	773.204	1x	442 131 06 80	-	 442.905-939 →  793998  440.907-911 →  794006
33	490.710	1x	442 131 28 80	-	 442.905-939  793999 →  440.907-911  794007 →
33/1	137.452	1x	442 131 29 80	-	 442.905-939 →  793998  440.907-911 →  794006
33/1	137.441	1x	442 131 22 80	-	 442.905-939  793999 →  440.907-911  794007 →
34	778.061	2x	442 492 00 80	-	-
35	106.909	8x	346 017 01 60	9,5x20x1 CU A	-
35	067.989	8x	346 017 02 60	9,5x20x1,5 CU A	-
43	759.296	2x	917003 026003	-	-
51	756.785	1x	442 018 00 80	-	-
54	765.735	1x	442 188 05 80	-	-



440.907 | 909

442.900 | 905-911 | 914-935 | 939



55	756.830	2x	442 141 07 80	-	-
55	764.485	2x	442 141 09 80	-	 442.930/931
59	768.392	1x	442 201 04 80	EWP/soft material	
59	463.250	1x	000 201 10 80	-	
59	680.271	1x	000 201 12 80	-	
61	538.120	16x	025 997 84 48	140x1,9 FPM RD	->  535118
61	538.120	8x	025 997 84 48	140x1,9 FPM RD	 535119 ->
61/1	703.214	8x	442 011 00 59	147,4x153,5x0,15 A	 535119 ->
61/1	863.020	8x	-	147,4x153,5x0,25 A	 535119 ->
61/1	896.455	8x	442 011 02 59	147,4x153,5x0,50 A	 535119 ->
62	538.090	16x	025 997 85 48	144x3,8 FPM RD	 Ø 145,8 mm
63	102.032	1x	014 997 61 48	78x3 NBR RD	-
76	558.060	8x	403 016 00 61	-	-